

# H2-1000KII

## SPO2 Simulator



Xuzhou Mingsheng Electronic Technology Co., LTD

Version: V 2.1

# Chapter 1: Instrument characteristics and performance

H2-1000KII SPO2 Simulator is a portable signal simulation tool specially developed by Xuzhou Mingsheng Company, which is used for the development and detection of blood oxygen saturation products. Because it can produce optical signals of different curves and different pulse amplitude, it is the necessary and preferred tool for the development of blood oxygen products. It has a wide signal amplitude range. It can simulate a variety of intensity and frequency of blood oxygen signals, which is an important tool to develop the measurement of blood oxygen products. The simulator also has the function of detecting blood oxygen measurement products, which is used to test whether the parameters of blood oxygen products can meet the requirements of national standards. The Settings in the detection process will be detailed in the following chapters.

## **H2-1000KII features the following:**

- Built-in four 18650 large-capacity lithium batteries, power management module, during use to ensure stable power supply, low interference output. External 9V DC power charger.
- Using menu operation, parameter change is simple, convenient, fast, convenient for users to set.
- A 2.8-inch color LCD screen is used to display menu contents.
- Simple key operation, menu management, easy to use, in addition to provide a shortcut key, in the development process can be a quick setting function.
- Built-in setting instructions in both Chinese and English, easy to understand the setting content.
- Equipped with encoder operation, all functional operations can be completed by an encoder.
- The simulator is a transmissible oximetry optical simulator.

## **H2-1000KII has the following properties:**

### **I .Simulation range of blood oxygen saturation:**

100%-71%, step size 1%, error  $\leq 1\%$ , initial value 98%

70%-35%, step size 1%, error  $\leq 2\%$

### **II. Pulse rate simulation range:**

300bpm-20bpm, step size is 1bpm, error  $\leq 1\text{bpm}$ , initial value 80bpm

### **III. Curve selection:**

BCI, NELLCOR, MINDRAY, MASIMO1, OxiMax, MASIMO2, EDAN, Creativ, BLT, Comen, GoldWay, Philips, GE Dash, ZonDon, Kantai, MASIMO

Initial value: NELLCOR

### **IV.Pulse signal amplitude range (PI value) :**

20%-0.1%, Initial value 4%

20%-1%, Step size 1%, 1%-0.1%, Step size 0.1%

Weak perfusion is the general term for pulse signal amplitude less than 0.2%

The transmittance intensity is adjusted automatically.

### **V. pulse intensity adjustment range:**

The highest pulse intensity was 20% when the blood oxygen was 100% to 77%.

The highest pulse intensity was 18% when blood oxygen was 76%.

When blood oxygen was 75%-71%, the highest pulse intensity was 15%.

When the blood oxygen was 70%-51%, the highest pulse intensity was 10%.

The highest pulse intensity was 8% when the blood oxygen was 50%-41%.

The highest pulse intensity is 6% at 40%-35% oxygen

**Note:When using NELLCOR or Mindray Curve, you must choose a 660nm/905nm oximetry probe for easy consistency with clinical data. When using BCI curves, use a 660nm/940nm oximetry probe for easy consistency with clinical data; Use the original MASIMO probe when selecting the MASIMO curve.**

## Chapter 2: H2-1000KII key definition

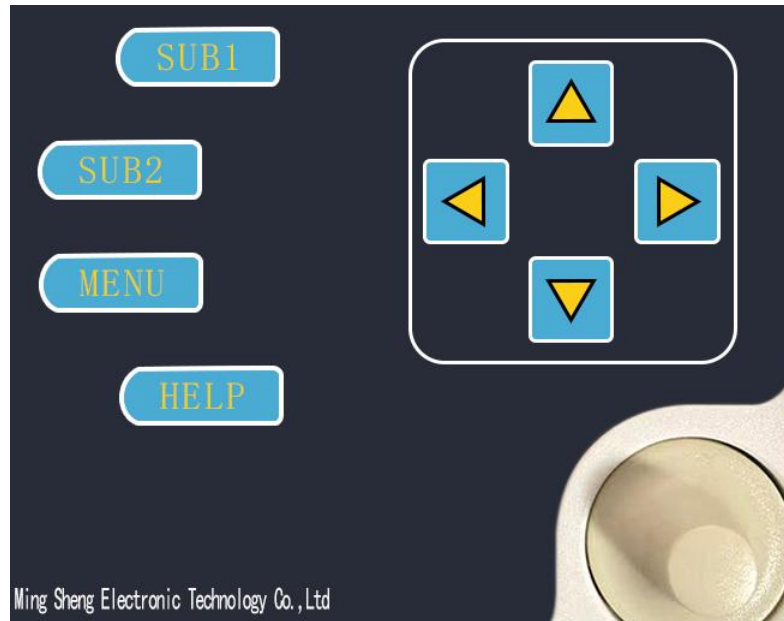

For the H2-1000KII, use ↑ up, ↓ down, left or right ← to perform software operations. You can use up or down to select menu items. In addition, the instrument is equipped with an encoder, and all operations can be operated through the encoder. The encoder has three key states: left turn, right turn and Enter button (representing "confirm").

**SUB1** : Quick set the blood oxygen saturation value group (blood oxygen, pulse rate, pulse intensity), the specific value is set in the menu.

**SUB2** : Quick set the blood oxygen saturation value group (blood oxygen, pulse rate, pulse intensity), the specific value is set in the menu.

**MENU**: Menu key. In any interface, select this key to enter the menu setting interface.

**HELP** : Help key to open the help description.

**Directional key**: Used to adjust the position of the cursor and change parameters.

**Encoder**: It is used for operation in the software interface. It has three functions: left turn, right turn, press (confirm).

## Chapter 3 Describes the H2-1000KII interface

The system main interface of H2-1000KII is shown in the figure below:

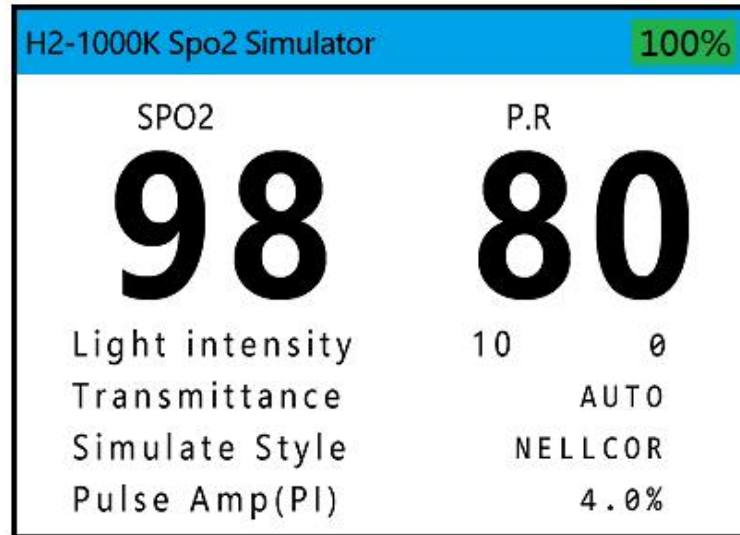

**SPO2 98:** Represents the value of blood oxygen saturation. When changing this value, each bit of this value can be changed separately to achieve the purpose of changing the value quickly. Variation range of oxygen saturation: 35%-100% minimum step size 1%.

**P.R 80:** Represents the pulse rate value, when changing this value, you can respectively change the value of each bit, to achieve the purpose of changing the value quickly.

**Light intensity :**The luminescence intensity of the blood oxygen probe was detected. The one with the highest value was infrared light intensity, and the other one was red light intensity.

**Transmittance:**Analog finger luminous intensity adjustment, can be set to automatic adjustment, used to detect the weak perfusion performance of the blood oxygen module, used to detect the limit parameters of the DC component of the blood oxygen equipment.

**Simulate Style:**BCI,NELLCOR,MINDRAY,MASIMO1,OxiMax,MASIMO2,EDAN,Creativ,BLT, Comen,GoldWay,Philips,GE Dash,ZonDon,Kantai,MASIMO.

**Pulse Amp(PI) :**20%,19%,18%,17%,16%,15%,14%,13%,12%,11%,10%,9%,8%, 7%,6%,5%, 4%,3%,2%,1%,0.9%,0.8%,0.7%,0.6%,0.5%,0.4%,0.3%,0.2%,0.1%.

## H2-1000KII menu setting screen:

Menu Setup			100%
Language	Eng	Power Off	Off
WaveStyle	Trig	LCD Powwe	Off
KeyDefine	Sub1	Spo2 Set	98
PRSet	80	PI Set	10.0%
Sensitivity	Normal	Light TRS	AUTO
Key Delay	6	Model	1000KII
Data Swit	Off		
LightStyle	Paces		Save
WWW.XZMSDZ.COM			Exit

**Language** : The optional languages are Chinese and English.

**Power Off** : Can set the system whether to choose automatic shutdown, and automatic shutdown time cycle.

**WaveStyle** : You can set the waveform shape of blood oxygen simulation, there are two options: triangle wave and pulse wave.

**LCD Powwe**:You can set whether the system chooses to automatically close the screen, and the time period for automatically closing the screen.

**KeyDefine** : You can set the key function of the instrument, respectively corresponding to the key panel SUB1 and SUB2, this function is to set the shortcut key, you can quickly set parameters through the key, the options are SUB1 and SUB2.

**Spo2 Set** :You can set the blood oxygen saturation value of the corresponding key in the shortcut key. When SUB1 or SUB2 is selected in the main interface, the blood oxygen value will be set quickly. The corresponding blood oxygen values of SUB1 and SUB2 can be set respectively.

**PR Set** :You can set the pulse rate value of the corresponding key in the shortcut key. When SUB1 or SUB2 is selected in the main interface, the pulse rate value will be set quickly. The pulse rate corresponding to SUB1 and SUB2 can be set respectively.

**PI Set** :You can set the pulse intensity value of the corresponding key in the shortcut key.  
When SUB1 or SUB2 is selected from the main interface, the pulse intensity value will be quickly set. Pulse intensity values (PI) corresponding to SUB1 and SUB2 can be set respectively.

**Sensitivity:**Normal, high, medium and low options are selected to improve the compatibility of some blood and oxygen devices.

**Light TRS** : The default setting is to automatically adjust the analog finger glow intensity.

**Key Delay:**When the button is pressed continuously, the delay time required by the automatic selection of the key.

**Model** :Optional machine model of this machine.

**Data Swit** : For some blood oxygen equipment in the detection, due to the probe will lead to the mismatch with the analog finger, resulting in a reverse change between the blood oxygen value and the set value, please change this item to open, to solve this problem.

**LigheStyle:**Pulse and continuous two options.

**Save** :After selecting this item, please rotate the encoder to save the Settings.  
When the Settings are completed, the Settings will be saved.

**Exit** :Return to the main window.

## Chapter 4: H2-1000KII hardware connection description

The H2-1000KII uses an external analog finger to connect the oximetry apparatus, as shown below:

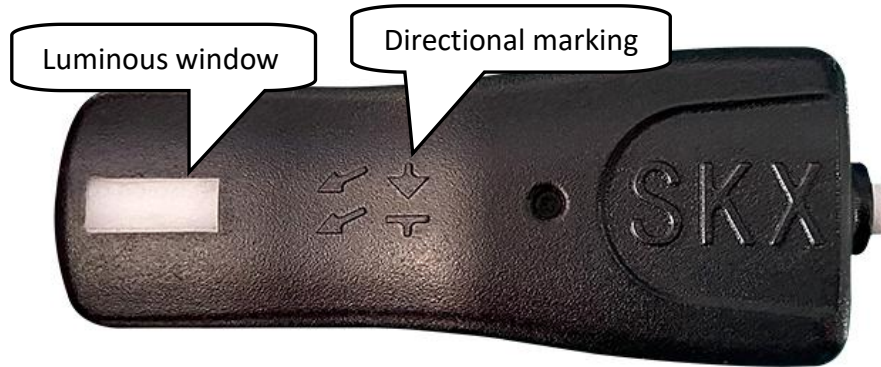

Figure 1

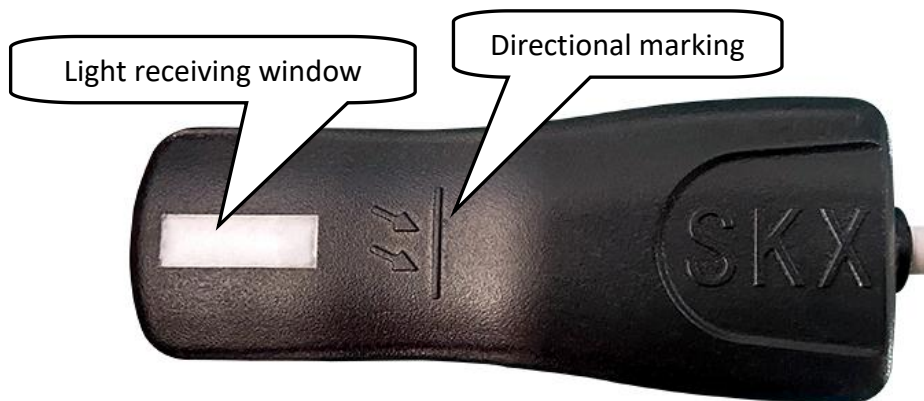

Figure 2

As shown in the figure above, Figure 1 is the luminous end of the simulated finger, and Figure 2 is the receiving end of the simulated finger.

### Method of connection of blood oxygen probe:

1. Please align the simulated finger as shown in Figure 2 with the luminescent tube part of the blood oxygen probe;
2. As shown in Figure 1, please point the simulated finger at the receiving tube of the blood oxygen probe. Please note that the light emitting window in the white part of the picture is aligned with the receiving tube.
3. After normal connection, the luminescent tube of the blood oxygen probe will turn into a steady light. If the luminescent tube of the blood oxygen probe is always changing, please continue to adjust the position of the simulated finger.



## Chapter 5: After-sales service

- ◆ The company will provide you with a one-year warranty from the date of installation of the monitor, the expiration of the warranty period, responsible for lifelong maintenance, and according to the provisions of the maintenance materials charges.
  
- ◆ Our company will not provide free warranty service for the failure caused by the following reasons:
  - Failure caused by unauthorized disassembly and modification of the product.
  - Analog finger damaged by external force, no longer provide warranty.
  - Fault caused by careless falls and drops during use and handling.
  - Failure due to lack of proper maintenance and failure to meet environmental requirements.
  - Failure caused by failure to follow the correct instructions in the operation manual.
  - Failure caused by self-repair without our company's permission.
  - Malfunctions caused by the irresistible forces of nature caused by natural disasters, fires, earthquakes, etc.
  
- ◆ If you need warranty service, please contact our technical service center directly by telephone, letter, fax and other forms, such as contact with other personnel or departments, there may be information transmission interruption, resulting in the misunderstanding of time and service, the most important or affect your normal use.
  
- ◆ After-sales service information:
  - Full name: Xuzhou Mingsheng Electronic Technology Co., LTD
  - Address: 726, Building A, Shimao Diamond International, Yunlong District, Xuzhou City
  - ZIP Code: 221004
  - Telephone: 0516-83460606, 83469046
  - Chuanzhen: 0516-83469046
  - E-mail: [XZFRD@163.com](mailto:XZFRD@163.com)

## Appendix:

### Weak perfusion characteristics of blood oxygen saturation

Because the performance of digital oximetry mainly depends on the precision of digital probe, the performance of its receiving tube directly determines the weak perfusion performance of digital oximetry. Relative to the traditional analog signal method to get blood oxygen saturation, in a certain degree of weak perfusion, such as more than 1%, the performance of the digital probe is stronger than the analog probe, can improve anti-interference, mainly in no matter anyone's fingers thick or thin, children or newborns can get a good performance. When simulating blood oxygen in extreme fields such as newborn or children's fingers, if the fingers are very thin, the light transmittance of the fingers is too strong, which may cause misjudgment of the probe falling off detection. If the misjudgment is not caused, because the light transmission is too strong, it will lead to the front-end amplification part of the pulse detection circuit can not be simulated amplification, (because amplification will cause loss of pulse amplifier saturation state), so the waveform amplification function will be lost. In addition, because of the high light transmission intensity, although through adjusting the luminescence intensity of the luminescence tube, the received light intensity is still very strong. Therefore, in this state, the performance of analog blood oxygen is inferior to that of digital blood oxygen.

1. The digital oxygen receiving circuit has no limit on the light transmission intensity of the finger, so it improves the anti-interference ability in use and is suitable for a variety of people. However, the digital receiving tube has the potential to cause AC signal saturation after too strong DC signal. When the DC component is too large, it will cause the AC signal to work in an irregular interval, so it is suggested that the digital reception should come with luminous brightness adjustment, for the digital receiving tube work in a most reasonable space.
2. because the weak perfusion performance of digital blood oxygen completely depends on the performance of the receiving tube, so for a certain digital receiving tube, its weak perfusion performance is also determined, restricting the weak perfusion can not be further improved, after testing its weak perfusion performance can only be around 1%, can not be further improved.
3. Because the analog probe uses multistage signal amplification, for example, the pulse signal can be amplified and reduced through the adjustment of luminous intensity first, the pulse signal can be amplified by amplifying the pulse carrier signal, and finally the pulse signal can be amplified by high-precision AD and other ways to collect the pulse signal. Through the above three ways, the weak perfusion performance of blood oxygen can be improved, far more than the weak perfusion performance of digital probe. However, the above method has special circumstances, such as newborns or children, because the finger is small and thin, will lead to the finger light intensity is very strong, may lead to the first two kinds of signal amplification part performance failure, if you can overcome the above problems, the weak perfusion performance of the analog probe is much stronger than the digital probe.

## Test method of blood oxygen saturation:

The diode driving part can adjust the current through the diode to change the luminous intensity through the analog quantity

"SPO2\_DRV"

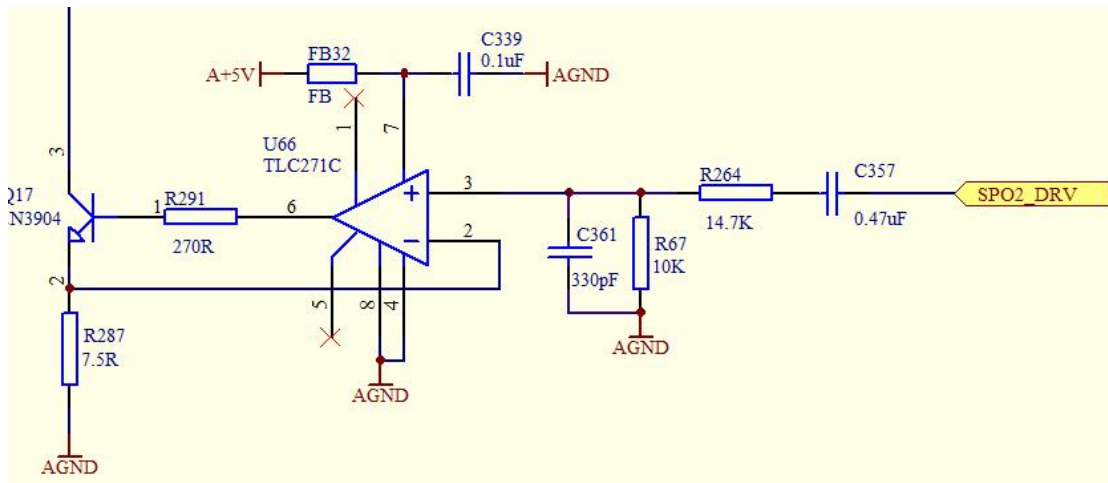

The tube alternately emits red and infrared light, similar to the following waveform

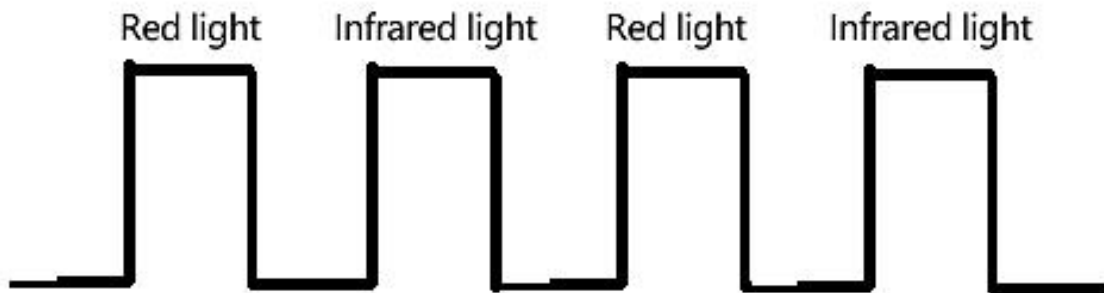

The cycle can be set by itself, but it should not be too fast. It should be controlled at about 2ms

The following waveforms are also acceptable.

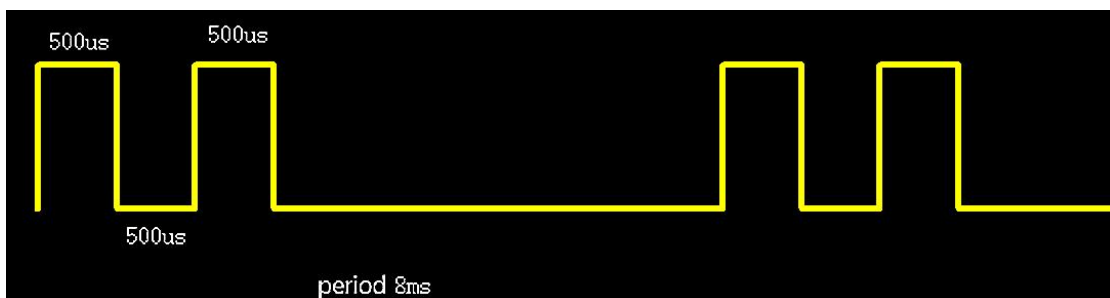

As shown in the figure above, the total period is 8ms, the red glow pulse is 500us, the infrared light emits after 500us interval, the period is also 500us, and then the rest of the cycle is all dark.

The sequential circuit of the blood oxygen device to drive the luminescent tube is shown below. There are four modes:

1. Red light and infrared light alternate, pulse period is the same, dark period and luminous period are equal.

The luminescence period can be set to 200us-1ms. The Dash series Nellcor module uses a 500us luminous cycle

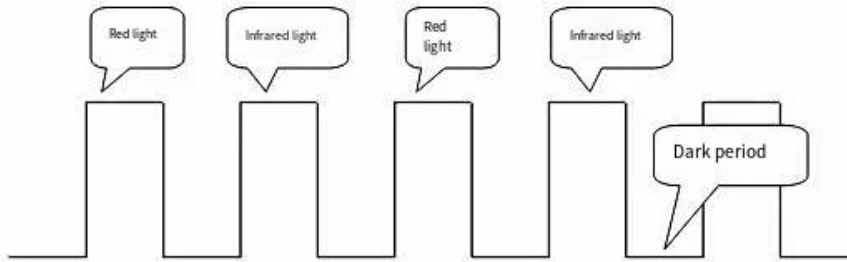

2. The timing sequence of red light and infrared light is fixed, as shown in the figure below: the luminous order of red light and infrared light can be interchanged, but the period is the same, the setting range is 200us-1ms, the dark period between red light and infrared light can be 200-1ms, and the luminous period between each group is fixed, which can be customized according to requirements, and the default can be set to 8ms.

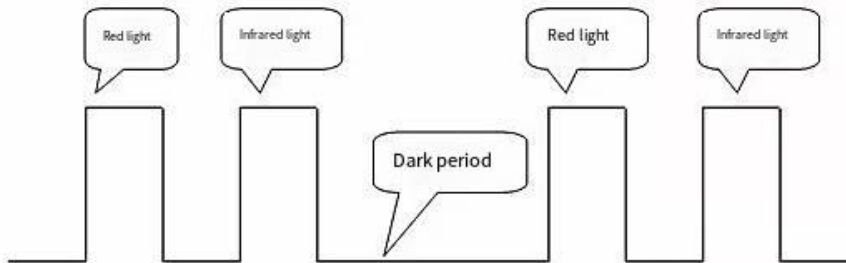

3. Red light and infrared light emit continuously with no dark interval or very small dark interval, less than 100us, as shown in the figure below

As shown:

In this case, each set of luminous cycles has a fixed interval, which can be defined as 8ns or other values

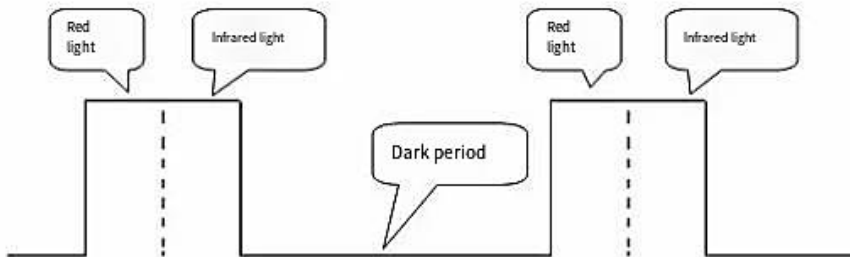

4. Red light and infrared light emit continuously with no dark interval or very small dark interval, less than 100us, as shown in the figure below

As shown:

In this case, the red and infrared photoluminescence periods can be defined as 200us-ins, and each group of photoluminescence periods has a fixed interval, which can be defined as 8ns or other values

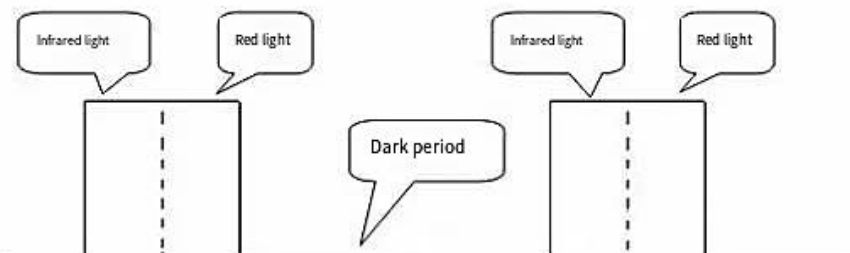

**Please note:** Spo2 Simulator can detect the first three conditions in four cases. If the blood oxygen device is the fourth luminescence driving condition, please adjust the luminescence timing to meet the three conditions. The first two driving modes are common in the market, please try your best to choose the first two driving modes.

Please try to use more than 200us for the driving time sequence of the light emitting tube. The test shows that there is a delay between the driving pulse level of the light emitting tube and the pulse level received by the silicon photocell. This delay is related to the hardware of the light emitting tube, and the time is about dozens of us. Please note this content when developing, it is recommended to sample before shutting off the pulse or at the intermediate point, and try to sample after 100us after the start of the drive pulse.

### Receiving tube section circuit

The waveforms received by the receiving tube after differential amplification are similar to the above luminous waveforms, except that the blood oxygen waveforms are already contained.

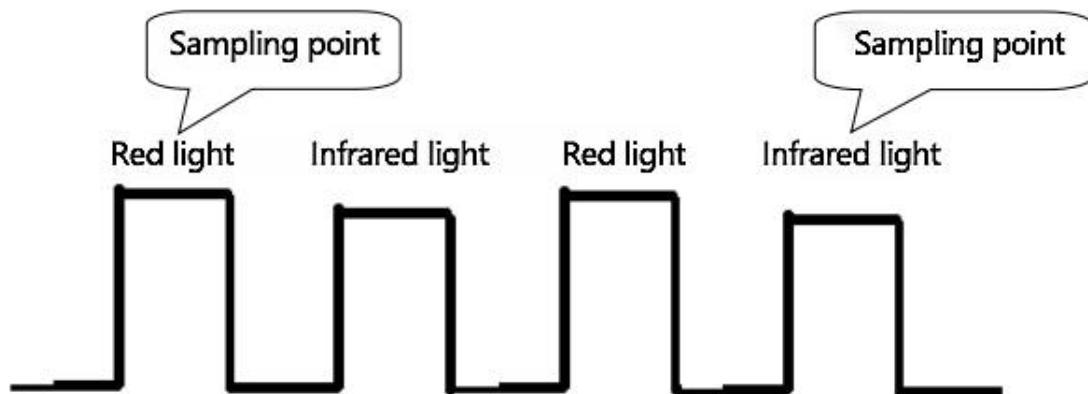

Similar to the above waveform, the blood oxygen waveform data has been contained. In this case, the waveform should be amplified according to the amplitude of the waveform, and then directly collected in the AD part of CPU. It should be noted that there is no need to separate the above waveform, but only need to follow the timing of the luminous part at the CPU program end. It is OK to collect waveform at the corresponding time point. It is suggested that AD signal should be collected after closing and switching the luminescence tube, so as to obtain effective data to the maximum extent. If the pulse width is wide enough, sampling can also be done at the middle point of the pulse.

## How to play the importance of instruments:

In the current research and development process of blood oxygen instruments, because it has been a public product, so many manufacturers have no longer to do clinical performance verification, often just use the simulator for calibration accuracy, and no longer invest a lot of energy in clinical verification, but the simulator is only a verification of accuracy and consistency of the instrument, does not represent can replace clinical verification; Therefore, only after the performance test of the analog instrument, it does not mean that it can pass many clinical verification, this point is particularly important to the attention of each research and development personnel.

In the development process of this simulator, the above factors were taken into account, so some functions were added to solve the above clinical verification problems. The specific methods are as follows:

The change of light transmittance intensity corresponds to the DC component in blood oxygen detection, and the light transmittance of fingers with different skin color and thickness. The detection range can be obtained by testing the performance of corresponding products of mature products on the market, because it has undergone a lot of clinical verification. Therefore, if the developed blood oxygen equipment can achieve its detection performance, it means that the clinical treatment is close to it. Please compare and refer to the blood oxygen products of the manufacturers such as Mindray Kinkway and Libon.

By setting the limit value of light transmittance intensity, the limit parameters of mature products can be measured, and these parameters can be used as the limit parameters of self-developed products, which can be quickly verified clinically.

By setting pulse intensity and comparing mature products, the limit parameters were obtained.

By setting the pulse slope value of triangular waveform, the limit parameters of mature products were obtained.

By comparing the limit parameters obtained by the above detection methods and applying them to the products developed by ourselves, we can approach the clinical performance as close as possible. Maximum product adaptability can be obtained through product comparison without clinical verification.

Please note that when comparing parameters, if you use an analog receiving tube, please compare the instrument with reference to the analog receiving tube, and the digital tube with reference to the instrument with reference to the digital tube, remember not to exchange the comparison.

In addition, in the process of testing mature products, it is found that when the level of the pulse group is raised before AD acquisition, it is better to dynamically adjust the level of the pulse group. In this way, the amplitude range of the pulse group before AD can always be maintained.

## Influence of hardware circuit on blood oxygen value:

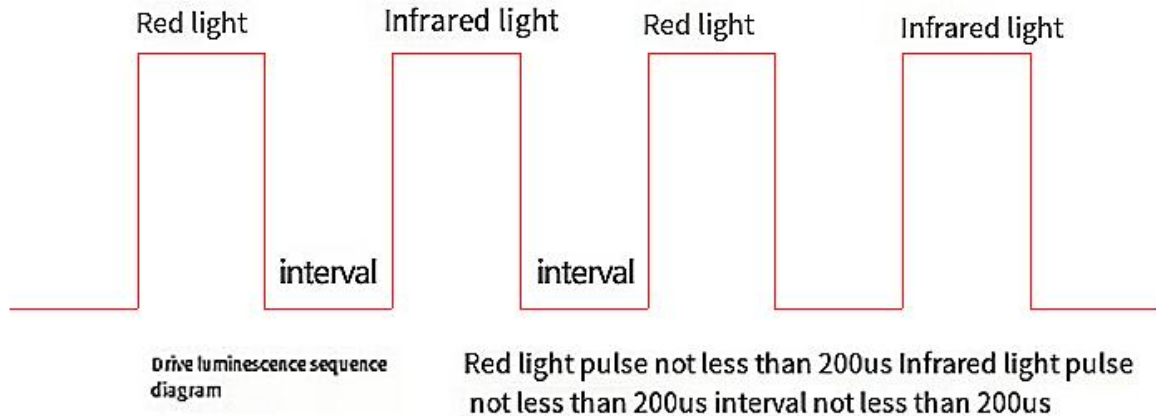

1. As shown in the figure above, the luminous drive should meet the above minimum requirements as far as possible due to the influence of hardware, so as to obtain a stable signal.
2. In red and infrared pulses, because of the influence of the hardware circuit, the pulse cannot be as steep as the theory. There is a rising cycle when the pulse goes up, and a falling cycle when the pulse goes off. When the blood oxygen simulator is used for calibration, because different simulators have a default threshold range for the rise cycle and fall cycle, switching cycle small devices should be selected for the luminous driven switching mos tube in the hardware circuit. Otherwise, the rise cycle and fall cycle will be too long due to the device factors. When correcting the R curve, Different simulators will lead to deviation in R curve calibration. The lower the blood oxygen value, the greater the deviation. As a result, the corresponding detection results of different simulators will be different, leading to numerical uncertainty. Therefore, it is suggested that the rise period and fall period of the switching mos tube that drives the luminescent tube should be less than 150us. The smaller the data is, the more stable it is relative to the simulator, and the smaller the difference between different blood oxygen simulators. Especially for digital receiving tubes, the longer the rising cycle and falling cycle time, the greater the impact of numerical deviation caused. Therefore, it is recommended to select the device, select the response period is small.
3. For the finger clip oximeter, in terms of both performance and energy saving, a 125Hz sampling rate with a pulse period of 200us-250us and an interval of 200us-250us and a total cycle of 8ms is better for the stability of blood oxygen value and pulse rate. For the blood oxygen instrument that does not need energy saving, the pulse cycle is controlled at 500us and the total cycle is 8ms.